

# edilportale<sup>®</sup>

## TOUR 2014

La mostra convegno in 18 tappe  
su Efficienza energetica,  
Luce e Ventilazione naturale,  
Acustica e Active House.

in collaborazione con

**VELUX<sup>®</sup>**

partner

**SCHÜCO**

**ROCKWOOL**  
PERFORMANCE INSULATION

**knauf**

**Udine 6 giugno 2014**

**Soluzioni con i sistemi a secco per il comfort acustico e  
l'efficienza energetica nella ristrutturazione**

**Ing. ZAMUNER Edoardo**

# **knauf**

**Pareti di tamponamento**

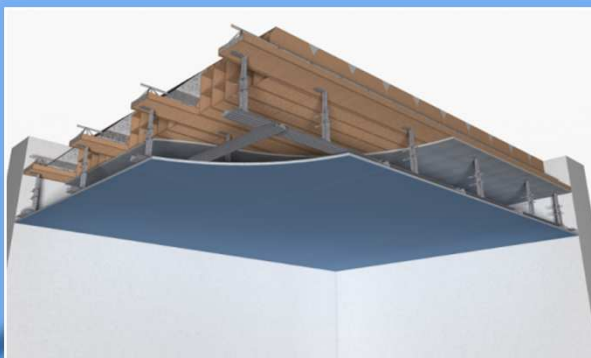

**Controsoffitti**

**Contropareti interne**

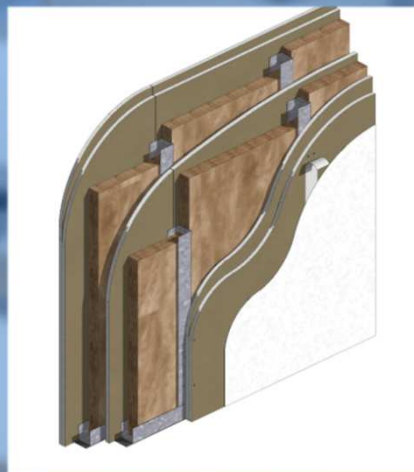

**Pareti interne**

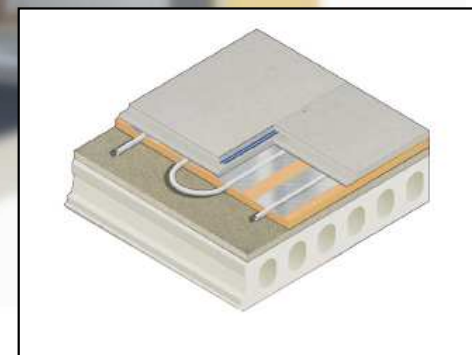

**Massetti a Secco**



**Contropareti esterne**

**Sistema a secco per esterno**



**Sistema a secco per Interni**



## Sistema a secco per esterno Aquapanel<sup>®</sup>



Sistema Isolamento  
termoacustico per Interni





## **Il Sistema a Secco per esterno**

**AQUAPANEL**<sup>®</sup>

## Quali sono i vantaggi nel costruire completamente a secco?



### **Risparmio economico**

- **Tempi di costruzione più rapidi**
- **Realizzazione più rapida dell'involucro**  
= partenza anticipata dei lavori all'interno
- **Aumento della superficie utile**
- **Costi complessivi dell'edificio inferiori**

## Quali sono i vantaggi nel costruire completamente a secco?



### Risparmio economico

- Tempi di costruzione più rapidi
- Realizzazione più rapida dell'involucro  
= partenza anticipata dei lavori all'interno
- Aumento della superficie utile
- Costi complessivi dell'edificio inferiori

### Sostenibilità

- Riduzione fino al 50% del fabbisogno di energia primaria per la produzione
- Riduzione del 30% di CO<sub>2</sub> grazie alla tecnica costruttiva che richiede spessori e pesi ridotti
- Maggiore rispetto per l'ambiente grazie al minore consumo di risorse naturali

## Quali sono i vantaggi nel costruire completamente a secco?



### Risparmio economico

- Tempi di costruzione più rapidi
- Realizzazione più rapida dell'involucro  
= partenza anticipata dei lavori all'interno
- Aumento della superficie utile
- Costi complessivi dell'edificio inferiori

### Sostenibilità

- Riduzione fino al 50% del fabbisogno di energia primaria per la produzione
- Riduzione del 30% di CO2 grazie alla tecnica costruttiva che richiede spessori e pesi ridotti
- Maggiore rispetto per l'ambiente grazie al minore consumo di risorse naturali

### Prestazioni

- Maggiori prestazioni a parità di spessore
- Edifici più leggeri
- Ideali nelle ristrutturazioni senza necessità di consolidamenti
- Libera la fantasia progettuale
- Prestazioni sismiche superiori



### RIVESTIMENTO ESTERNO DI FACCIATA

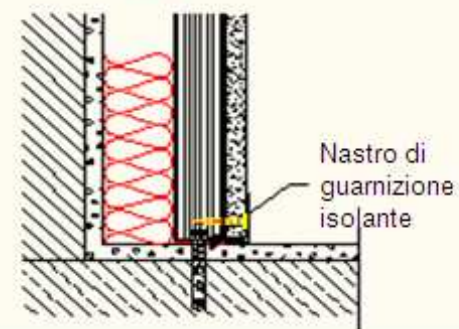
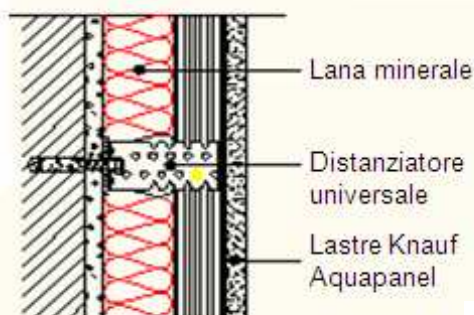
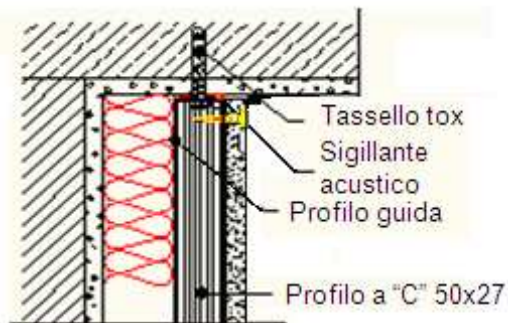

#### Esempio A

Muratura in laterizio alveolato tipo Poroton (700 Kg m<sup>3</sup>) da 20 cm con intonaco 15 mm su ambo i lati (U=0,9321 W/m<sup>2</sup>K)

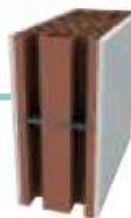

#### Esempio B

Parete doppia in semipieno da 12 cm e forato da 8 cm con intercapedine di 5 cm ed intonaco 15 mm su ambo i lati (U=1,2931 W/m<sup>2</sup>K)



Lastre Aquapanel Outdoor su orditura metallica C Plus 27/50/27, interasse 400 mm, acciaio Aluzink sp. 8/10 mm

Tipologia di Isolante	Spessore complessivo controparete	Trasmittanza termica U (W/m <sup>2</sup> K)	Sfasamento termico (h)	Classi climatiche soddisfatte <small>limite DLgs 311 al 01/01/2008</small>
Polistirene XPS spessore 60 mm	110 mm	0,3268	11h 49'	A - B - C D - E - F

Lastre Aquapanel Outdoor su orditura metallica C Plus 27/50/27, interasse 400 mm, acciaio Aluzink sp. 8/10 mm

Tipologia di Isolante	Spessore complessivo controparete	Trasmittanza termica U (W/m <sup>2</sup> K)	Sfasamento termico (h)	Classi climatiche soddisfatte <small>limite DLgs 311 al 01/01/2008</small>
Polistirene XPS spessore 80 mm	130 mm	0,2986	11h 11'	A - B - C D - E - F

## PARETI DI TAMPONAMENTO

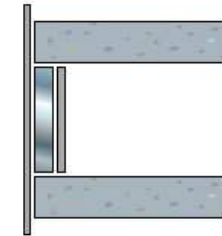
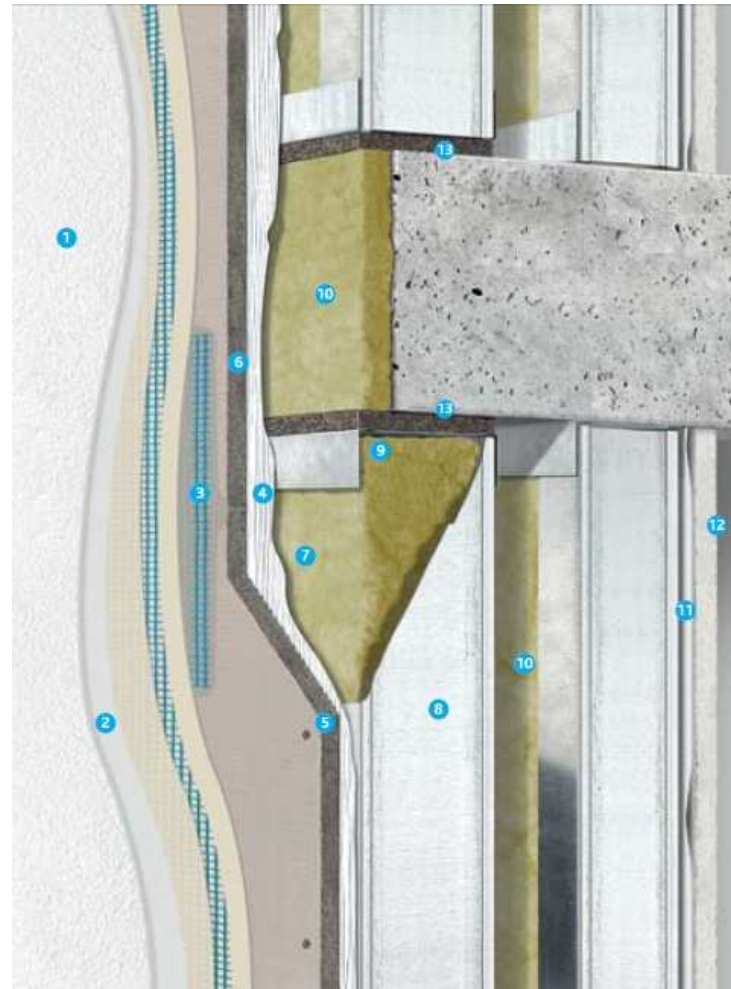

1. Finitura colorata
2. Aquapanel® Exterior Primer
3. Aquapanel® Exterior Basecoat + Aquapanel® Reinforcing Mesh
4. Aquapanel® Exterior Basecoat + Aquapanel® Reinforcing Tape
5. Aquapanel® Maxi Screw
6. Lastra Aquapanel® Outdoor
7. Aquapanel® Tyvek® StuccoWrap™
8. Profilo metallico Knauf a C MgZ®
9. Profilo metallico Knauf a U MgZ®
10. Lana di roccia Knauf IsoRoccia®
11. Lastra Knauf
12. Lastra Knauf più eventuale barriera al vapore
13. Isolante a taglio termico di spessore adeguato

**PARETI DI TAMPONAMENTO**

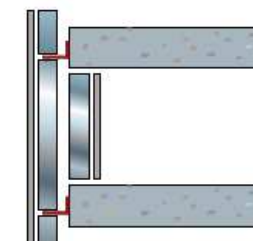
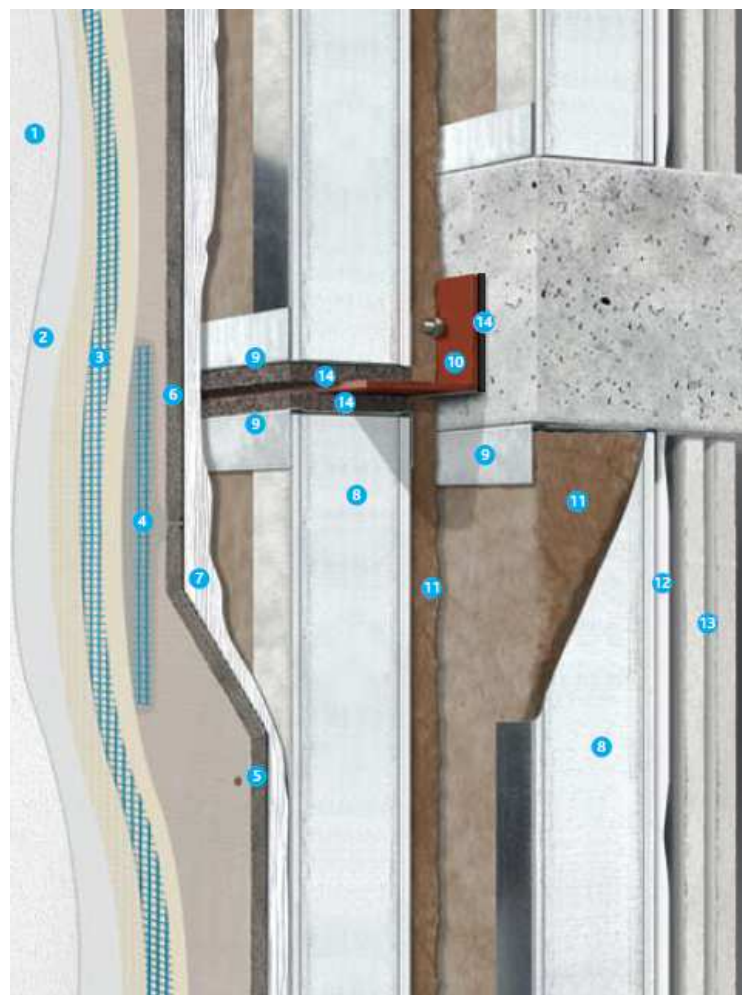

1. Finitura colorata
2. Aquapanel<sup>®</sup> Exterior Primer
3. Aquapanel<sup>®</sup> Exterior Basecoat + Aquapanel<sup>®</sup> Reinforcing Mesh
4. Aquapanel<sup>®</sup> Exterior Basecoat + Aquapanel<sup>®</sup> Reinforcing Tape
5. Aquapanel<sup>®</sup> Maxi Screw
6. Lastra Aquapanel<sup>®</sup> Outdoor
7. Aquapanel<sup>®</sup> Tyvek<sup>®</sup> StuccoWrap<sup>™</sup>
8. Profilo metallico Knauf a C
9. Profilo metallico Knauf a U
10. Profilati a L
11. Lana di vetro Knauf EkoVetro<sup>®</sup>
12. Lastra Knauf
13. Lastra Knauf con eventuale barriera al vapore
14. Isolante a taglio termico di spessore adeguato

## PARETI DI TAMPONAMENTO

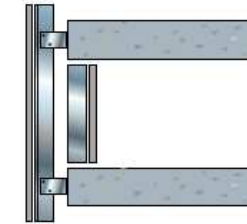
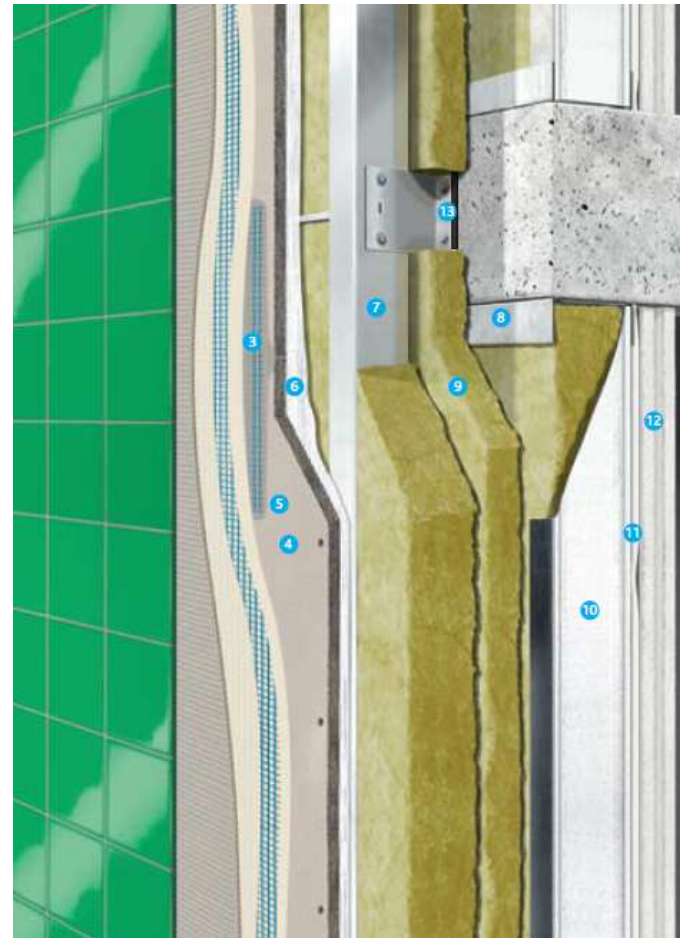

1. Rivestimento incollato su Aquapanel® Exterior Primer
2. Aquapanel® Exterior Basecoat + Aquapanel® Reinforcing Mesh
3. Aquapanel® Exterior Basecoat + Aquapanel® Reinforcing Tape
4. Aquapanel® Maxi Screw
5. Lastra Aquapanel® Outdoor
6. Aquapanel® Tyvek® StuccoWrap™
7. Profilo metallico Knauf a C MgZ®
8. Profilo metallico Knauf a U
9. Lana di roccia Knauf Isoroccia®
10. Profilo metallico Knauf a C
11. Lastra Knauf
12. Lastra Knauf più eventuale barriera al vapore
13. Isolante a taglio termico di spessore adeguato

## PARETI DI TAMPONAMENTO

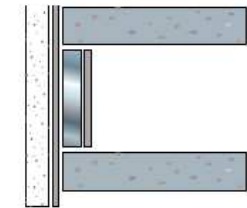

1. Finitura Colorata Knauf
2. Sistema Cappotto Termico Knauf (SCT)
3. Collante Knauf SM700/SM760
4. AQUAPANEL® Exterior Basecoat + AQUAPANEL® Exterior Reinforcing Tape
5. AQUAPANEL® Maxi Screw
6. Lastra AQUAPANEL® Outdoor
7. AQUAPANEL® Tyvek® StuccoWrap™
8. Profilo metallico Knauf a C
9. Profilo metallico Knauf a U
10. Lana di vetro Knauf EkoVetro®
11. Lastra Knauf
12. Lastra Knauf con eventuale barriera al vapore

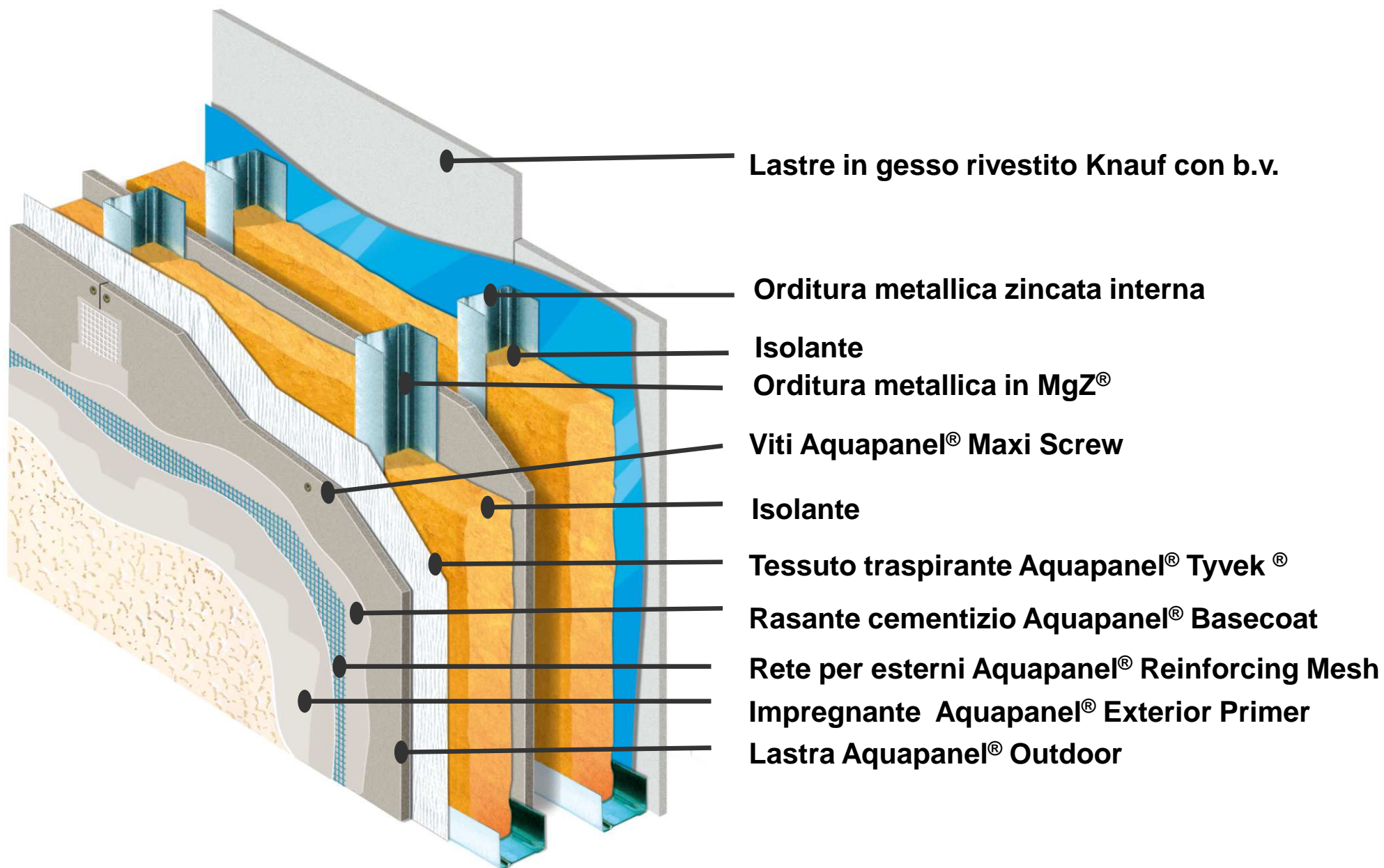

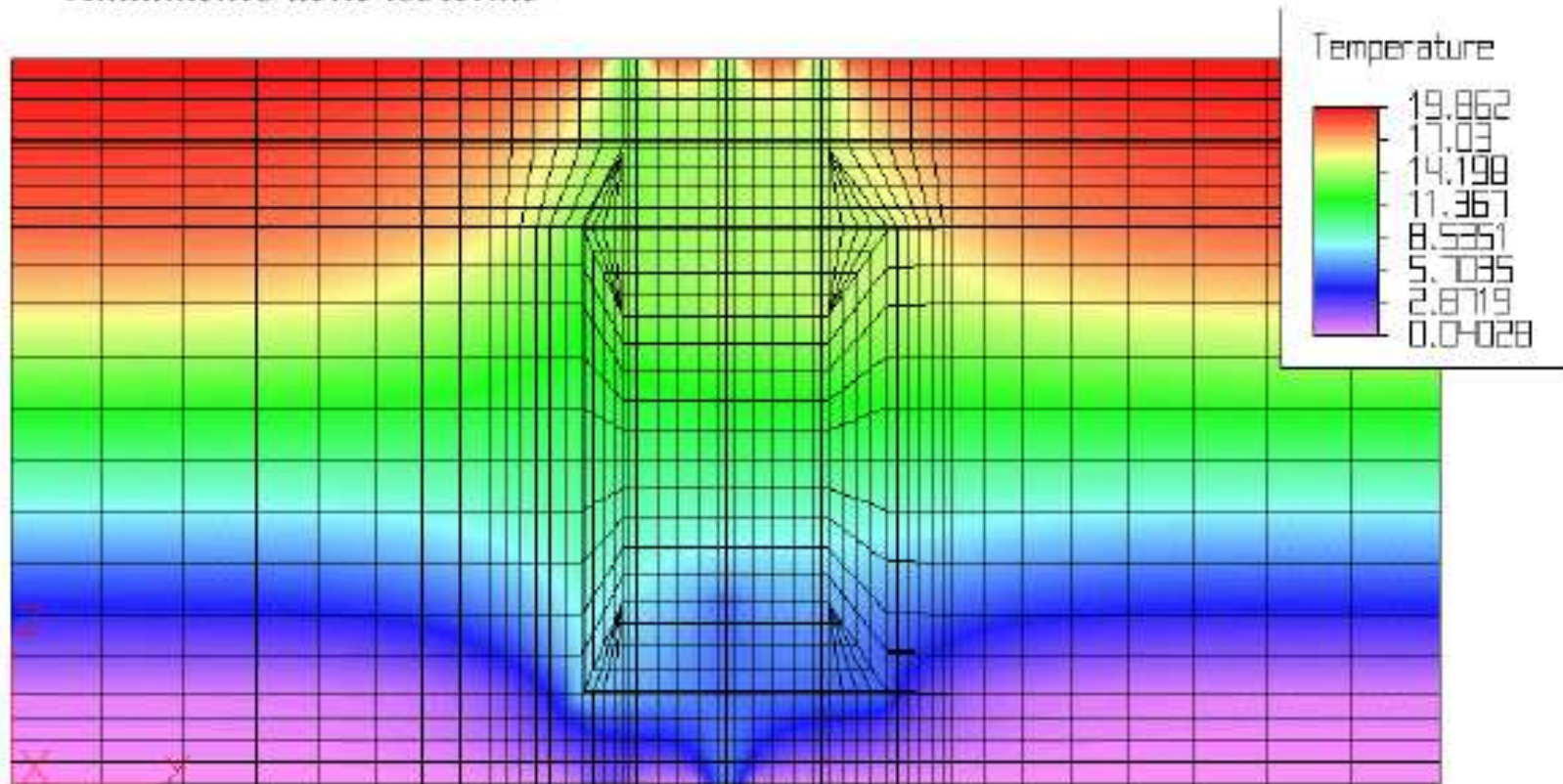

- Parete perimetrale singola struttura

## Perché la doppia orditura?

*Andamento delle isoterme*

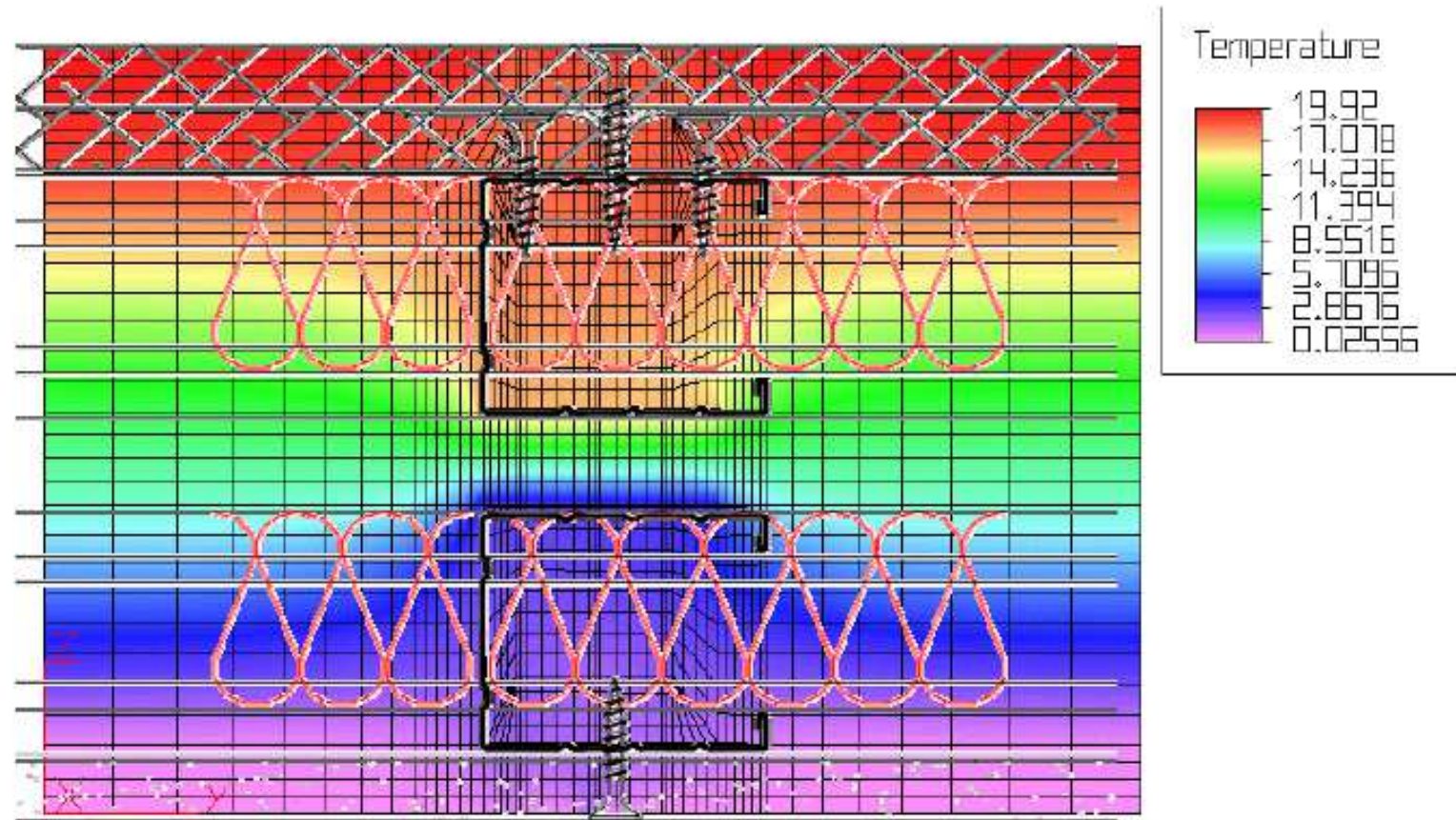



### Il collegamento con la struttura portante

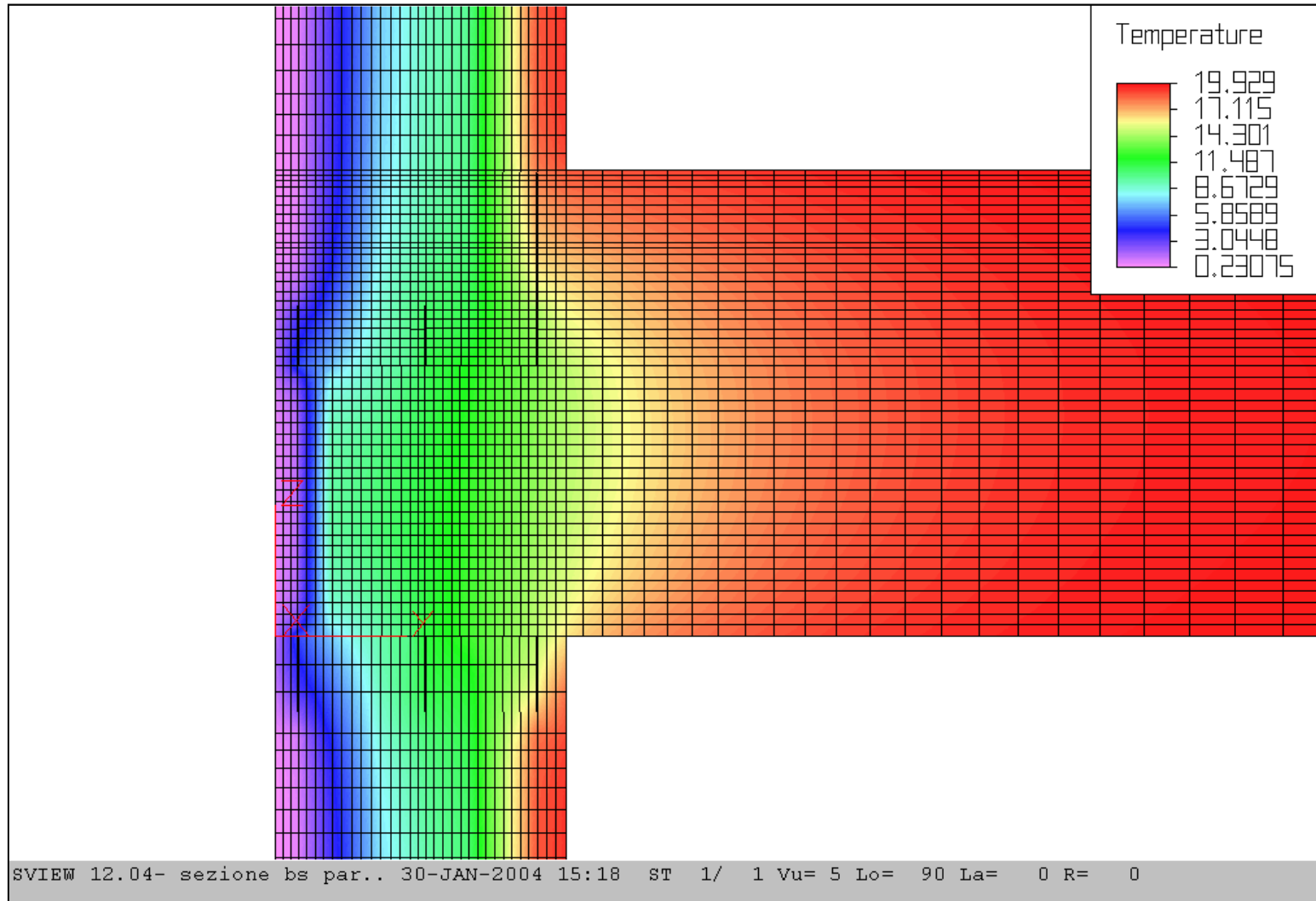

**edilportale**<sup>®</sup>  
TOUR 2014

**AQUAPANEL**<sup>®</sup> OUTDOOR  
Centro direzionale Milanofiori, Milano

**KNAUF**



**Centro direzionale Milanofiori, Milano**



**Centro direzionale Milanofiori, Milano**





**Sede Ordine Ingegneri, L'Aquila**



**Sede Ordine Ingegneri, L'Aquila**



**Sede Ordine Ingegneri, L'Aquila**



**Sede Ordine Ingegneri, L'Aquila**





**Sede Ordine Ingegneri, L'Aquila**



**Sede Ordine Ingegneri, L'Aquila**

## Sistema Isolamento termoacustico per Interni

Sistema a secco per  
esterno Aquapanel<sup>®</sup>



## CONTROPARETI E CONTROSOFFITTI E MASSETTI A SECCO AD ELEVATE PRESTAZIONI ACUSTICHE E TERMICHE

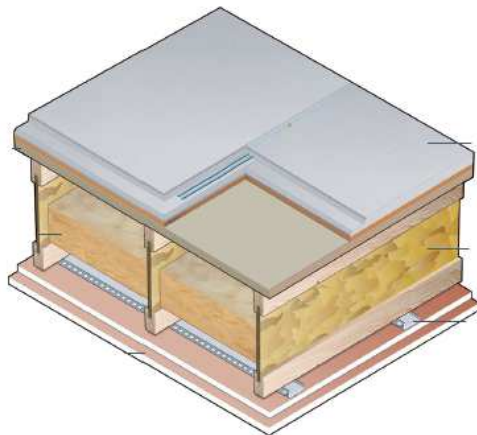



■ **Controparete W625**

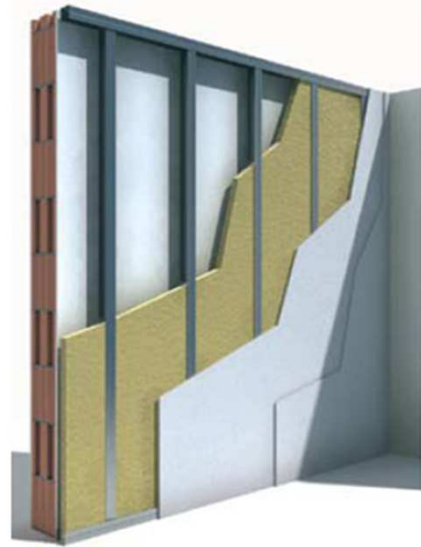

■ **Rivestimento isolante W624**

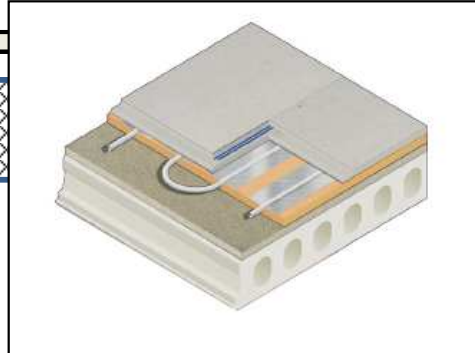
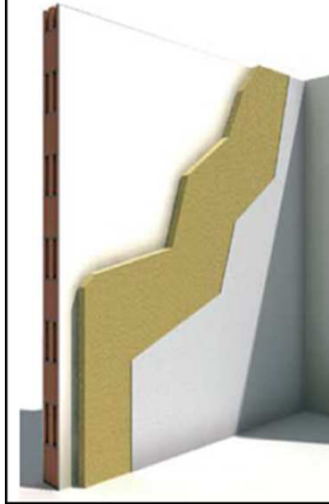

### CONTROPARETI AD ELEVATE PRESTAZIONI ACUSTICHE E TERMICHE



- Muratura
- Isolante Knauf in lana minerale
- Profilo Knauf C Plus 27/50/27 mm, ad interasse 600 mm
- 1 Lastra Knauf GKB, spessore 12,5 mm (A13) con interposta barriera al vapore in lamina di alluminio spessore 15 µm

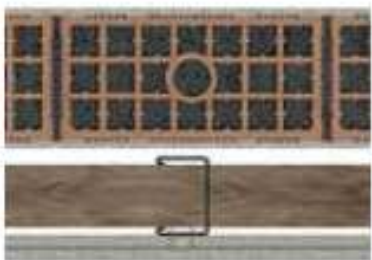

- Muratura
- Intercapedine 1 cm
- Profilo Knauf C50/75/100 mm
- Isolante Knauf in lana minerale
- 1+1 Lastra Knauf GKB, spessore 12,5 mm (A13) con interposta barriera al vapore in lamina di alluminio spessore 15 µm

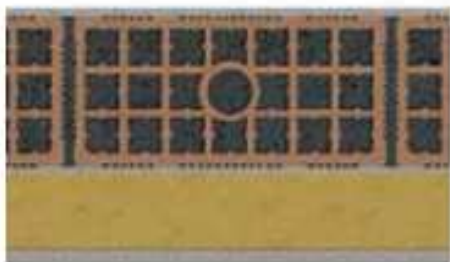

- Muratura
- Isolante
- Isolastra Knauf LM/PSE/XPS/FPE

#### ■ Controparete W623

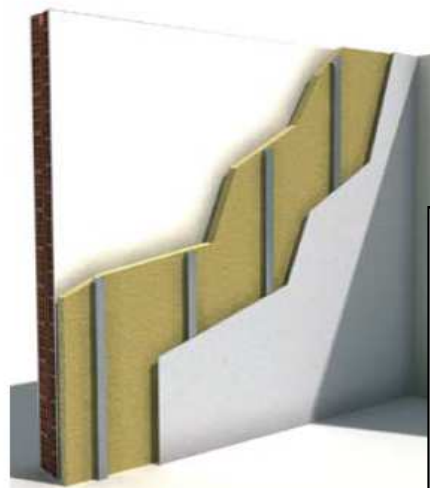

#### ■ Controparete W625

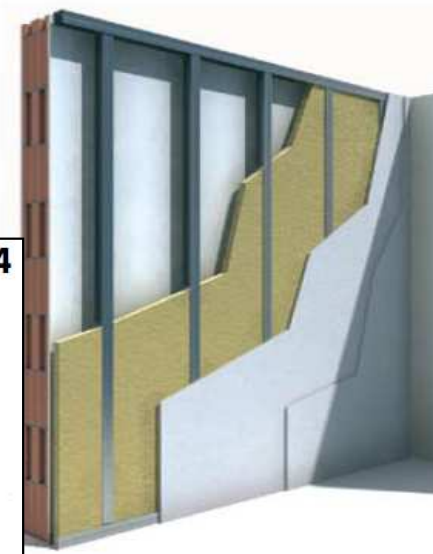

#### ■ Rivestimento isolante W624



**LE LASTRE**

*Lastre in gesso rivestito*

■ **Controparete Knauf W624 - Rw 56 dB**

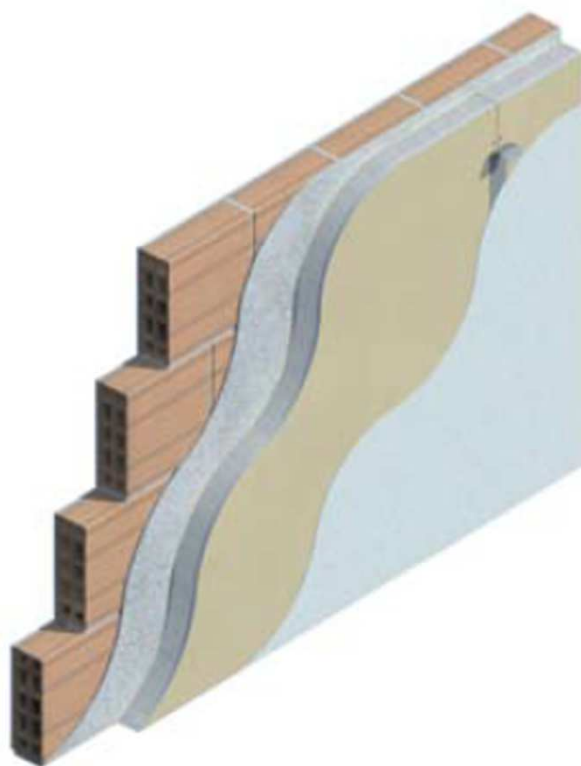

**Descrizione**

Controparete con Isolastra FPE 12,5 + 40 mm incollata con Knauf Perfix su una parete in forati da 8 cm intonacata in ambo i lati con intonaco di spessore 1 cm.

Controparete Knauf W624 - Rw 56 dB		
Stratigrafia	Materiale	Spessore mm
1	intonaco	10
2	muratura in laterizio	80
3	intonaco	10
4	Isolastra FPE	52,5
Potere fonisolante: Rw = 56 dB		
Spessore totale: 152,5 mm		

kg/m<sup>3</sup>

## Controparete Diamant® - FPE

Novità



### Controparete interna formata da Lastra Diamant®-FPE 20

Incollata tramite adesivo a base gesso **Knauf Perfix** su laterizio forato da 8 cm con 1,5 cm di intonaco per lato.

Potere fonoisolante: **55 dB**

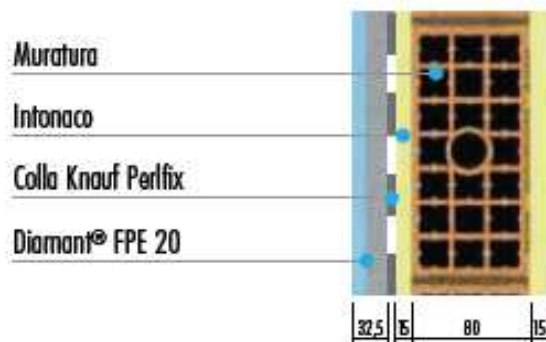

### Controparete interna formata da Lastra Diamant®-FPE 40

Incollata tramite adesivo a base gesso **Knauf Perfix** su laterizio forato da 8 cm con 1,5 cm di intonaco per lato.

Potere fonoisolante: **57 dB**

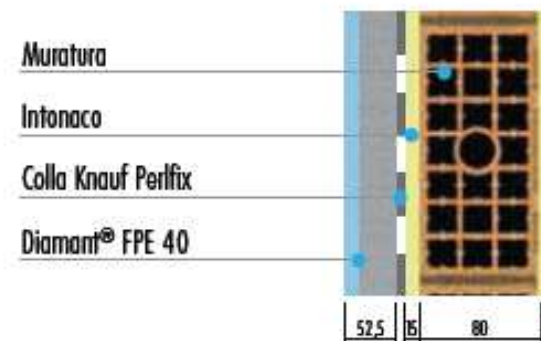



## Controsoffitti

### ■ Controsoffitto in aderenza D111



- Solaio
- Isolante
- Profilo Knauf C Plus 27/50/27 mm, ad interasse 500 mm
- Lastra Knauf GKB, spessore 12,5 mm con barriera al vapore in lamina di alluminio spessore 15 µm

Rw 49 dB



Rw 63 dB



Rw 68 dB

Ln,w 88 dB



Ln,w 61 dB



Ln,w 53 dB



Silentboard

■ Controsoffitto ribassato D112



- Solaio
- Intercapedine di 20 cm
- Isolante
- Lastra Knauf GKB, spessore 12,5 mm con barriera al vapore in lamina di alluminio spessore 15 µm

Rw 49 dB



Rw 69 dB



Rw > 70 dB

Ln,w 88 dB



Ln,w 50 dB



Ln,w 45 dB



Silentboard

Singola struttura e singola lastra di rivestimento

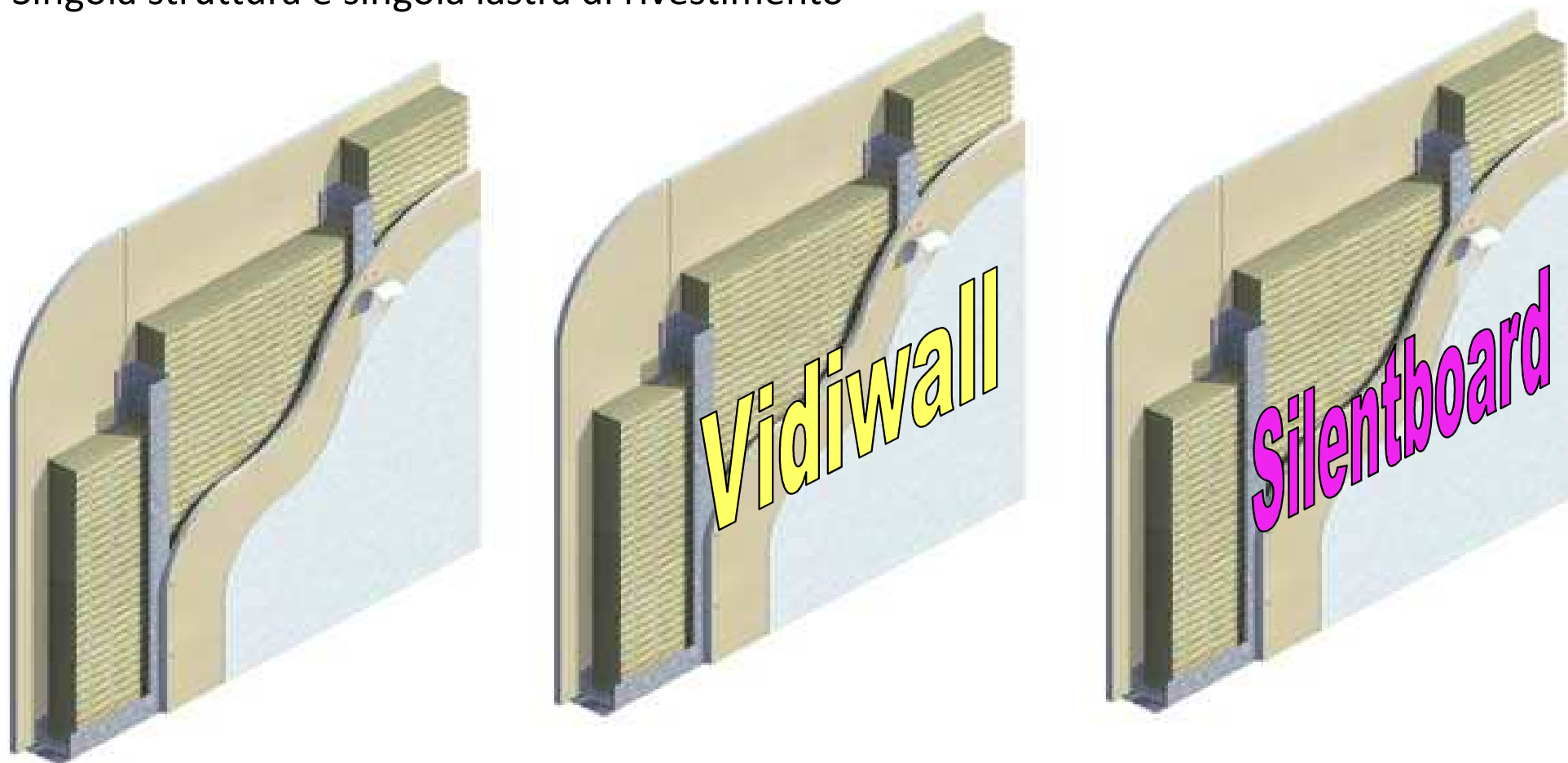

Rw 46 dB



$\Delta$  6 dB

Rw 52 dB



$\Delta$  2 dB

Rw 54 dB

Singola struttura e singola lastra di rivestimento

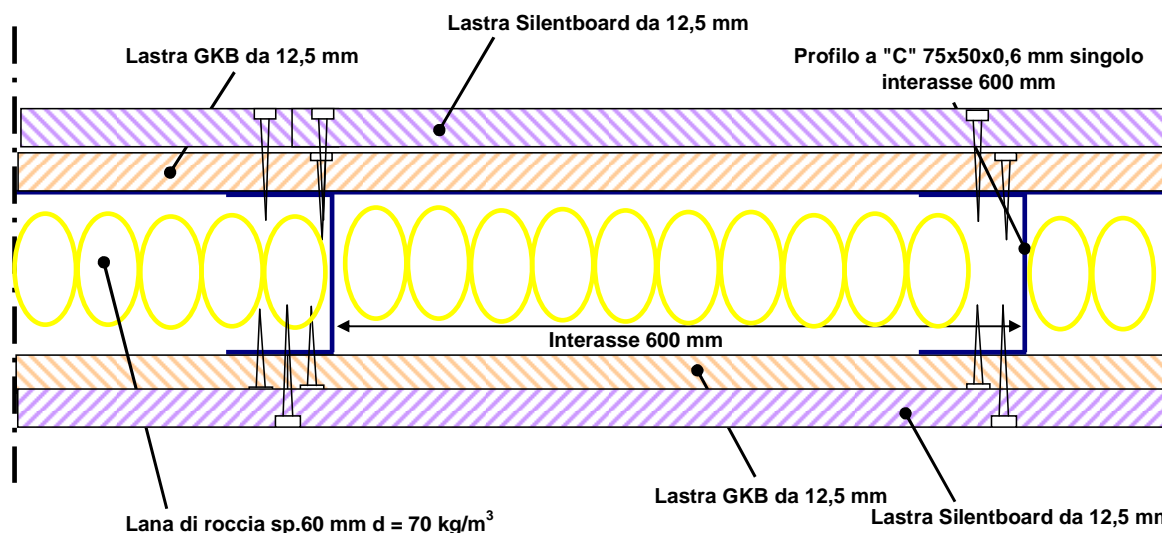

Spessore 100 mm, peso lastre 19 kg/m<sup>2</sup>  $R_w = 46 (-4;-10)$  dB



$\Delta 10$  dB

Spessore 125 mm, peso lastre 54 kg/m<sup>2</sup>  
 $R_w = 56$  dB

Singola struttura e doppia lastra di rivestimento

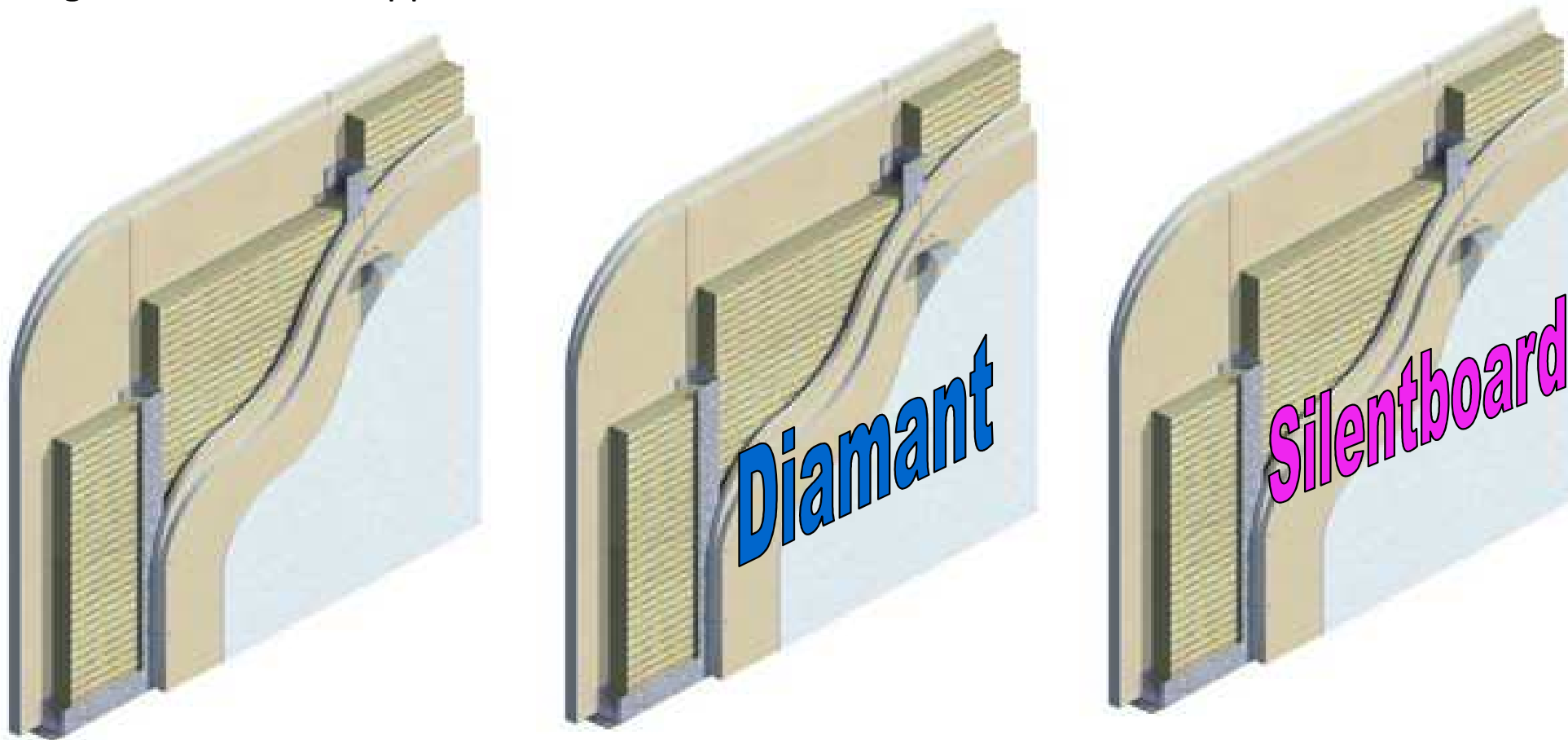

Rw 54 dB



Rw 56 dB



Rw 66 dB

## Pareti RIQUALIFICAZIONE ACUSTICA

Singola struttura e doppia lastra di rivestimento

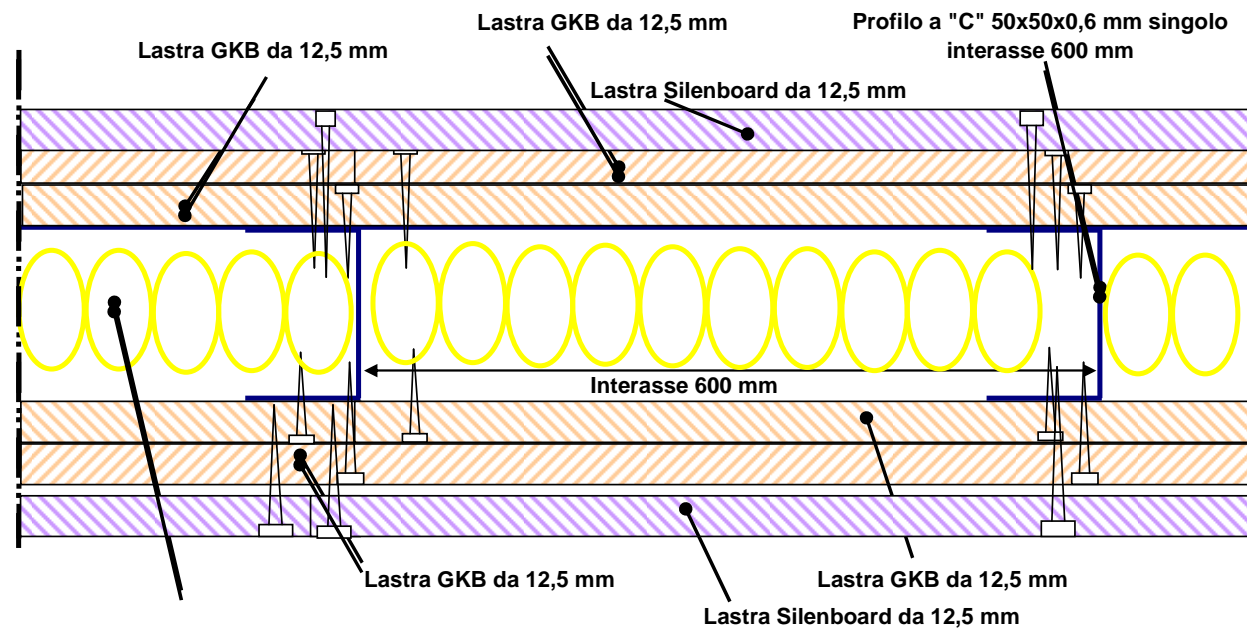

Spessore 100 mm, peso lastre 43 kg/m<sup>2</sup>  $R_w = 54$  (-4;-10) dB



Spessore 125 mm, peso lastre 54 kg/m<sup>2</sup>  $R_w = 66$  dB

Doppia struttura e doppia lastra di rivestimento

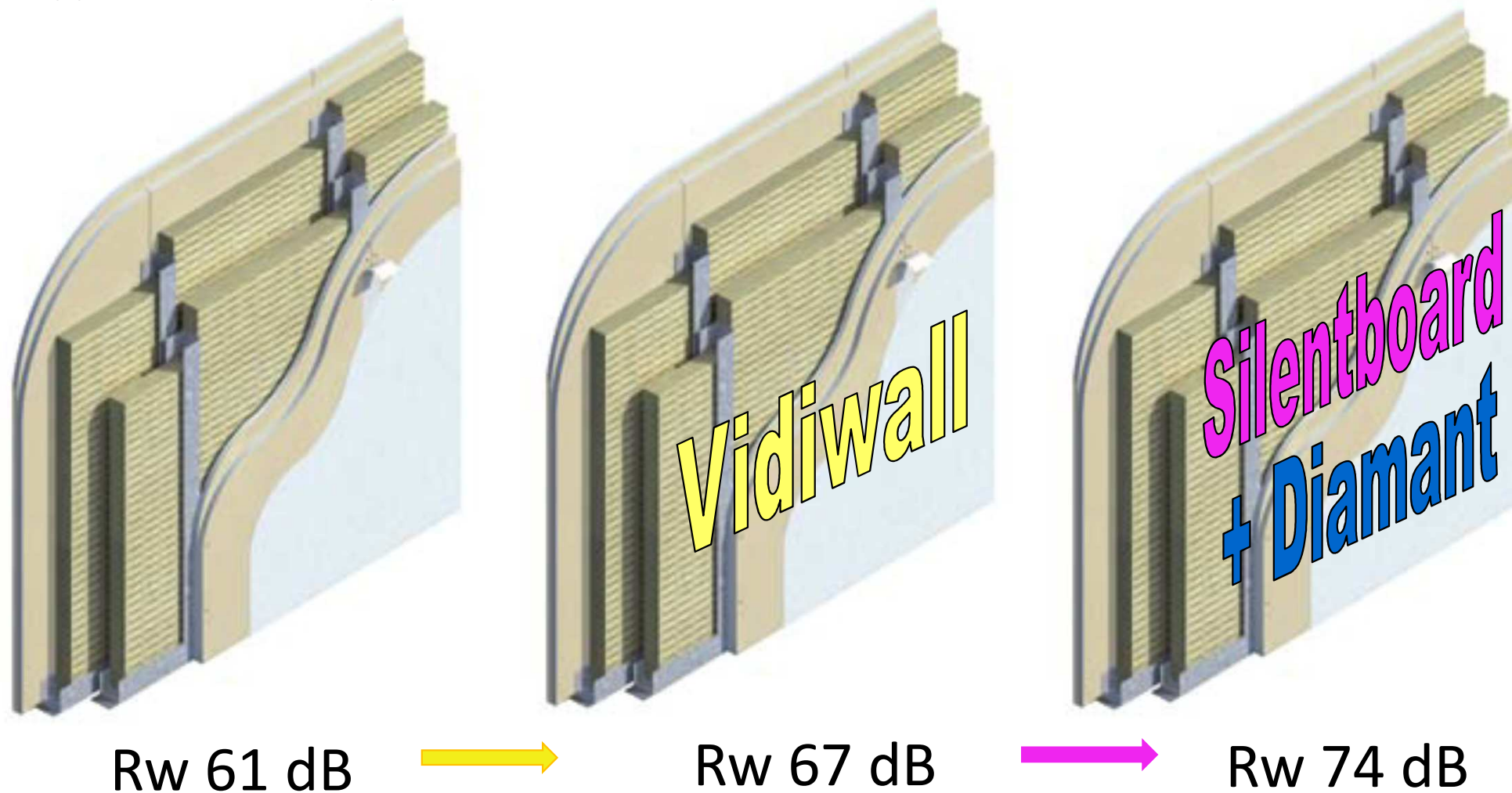

- ✓ **Software di progettazione e preventivazione BDS 3.0 online**

**Nuovo BDS 3.0** *Sistema di progettazione e preventivazione*

Utilizza il sistema BDS per progettare e preventivare i sistemi costruttivi Knauf, sfruttando le potenzialità online del BDS.  
Accedi ORA per iniziare un preventivo o analizzare un capitolato.

**Accedi ORA  
al servizio on-line** 



- Web Site: [www.knauf.it](http://www.knauf.it)

**Grazie per l'attenzione**